



DISPLAY AND EXHIBIT SOLUTIONS WORLDWIDE

## ROLL-UP GRAPHIC MOUNTING AND SERVICE MANUAL

This booklet contains procedures for graphic panel mounting and servicing your Roll-Up. We recommend that a Nimlok distributor perform the servicing. However, we have made these instructions as clear as possible for anyone to use as a reference. Please read each procedure and acquire the recommended materials before beginning. It is imperative that you follow these procedures to get a long and reliable life from the unit.

There are **three main points** throughout this manual that must be followed!

1. Do not remove the pin from the end of the unit until the graphic is applied.
2. Clean all surfaces that are to be bonded to the adhesive with denatured alcohol.
3. After applying the graphic panel, allow the tapes to cure for 24 hours under no tension before using.

## CONTENTS

PAGE	HOW TO.....
1-2	MOUNT A GRAPHIC PANEL FOR THE FIRST TIME
3-4	REPLACE AN EXISTING GRAPHIC PANEL
5	REAPPLY A GRAPHIC PANEL TO THE ROLLER
6	WHAT TO DO WHEN YOU ACCIDENTALLY PULL THE PIN

LAMINATED GRAPHIC DIMENSIONS	33 3/8" X 94 1/2" 850mm X 2400mm
GRAPHIC IMAGE DIMENSIONS	33 3/8" X 84 1/2" 850mm X 2146mm

# HOW TO MOUNT A GRAPHIC PANEL FOR THE FIRST TIME

**DO NOT REMOVE THE HEX KEY IN THE END OF THE UNIT  
UNTIL THE GRAPHIC PANEL IS APPLIED!**

THE FOLLOWING ITEMS WILL BE NEEDED TO SET-UP YOUR NEW ROLL-UP.

DENATURED  
ALCOHOL



CLOTH TOWEL



NEW HANDLE  
& MOUNTING STRIP (SUPPLIED)

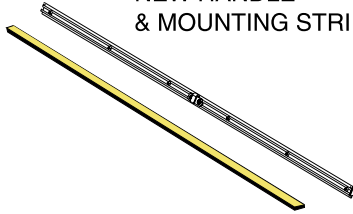

PHILLIPS  
SCREWDRIVER

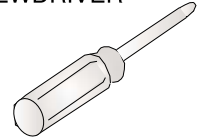

**1**

Apply denatured alcohol to a clean cloth and wipe the back side of the graphic. On the mounting strip, peel off the covering on the adhesive and mount the strip to the top backside of the graphic.

**2**

Slip the mounting strip & graphic into the clamping channel in the handle.  
(See DIAGRAM 1)

DIAGRAM 1

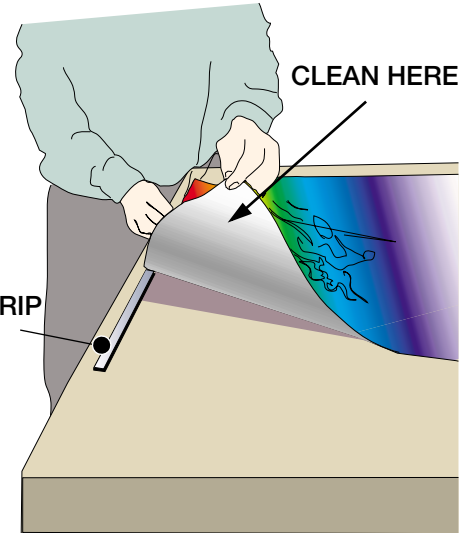
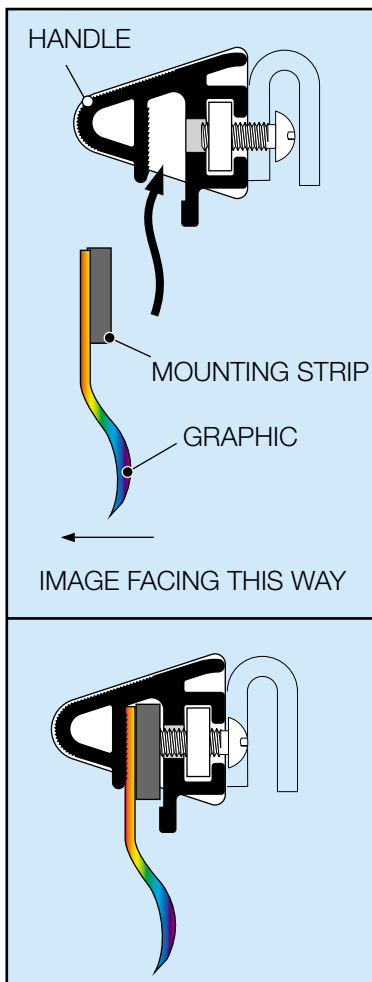

MOUNTING STRIP

CLEAN HERE

**3**

While holding the graphic panel into the handle slot, tighten the six mounting screws. Be sure not to over tighten the screws.

BACKSIDE OF GRAPHIC

**DO NOT REMOVE  
THE BLACK PLASTIC  
CAPS!**

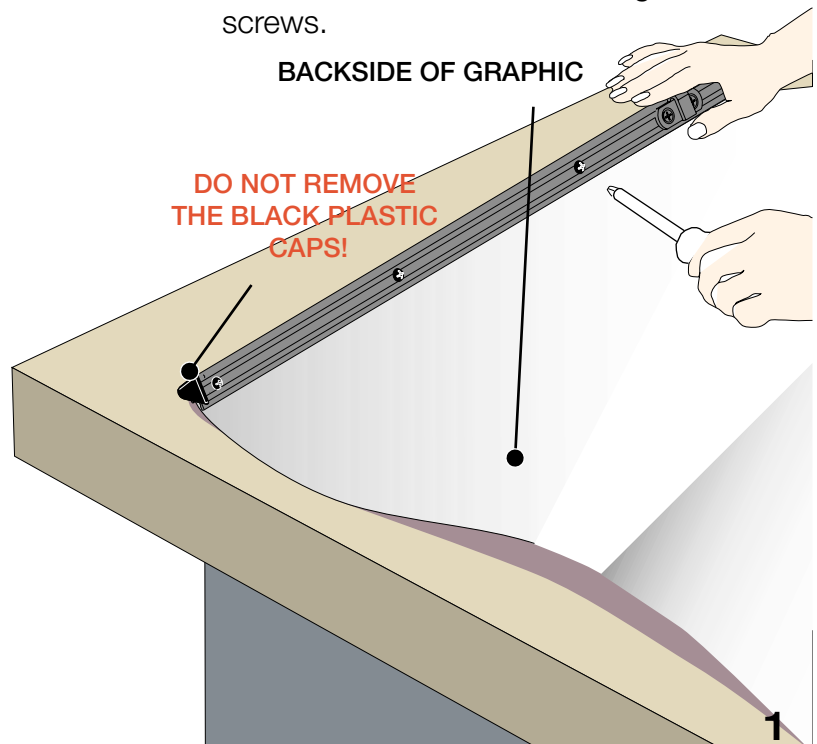

# HOW TO MOUNT A GRAPHIC PANEL FOR THE FIRST TIME

4

Wipe clean the bottom front of the graphic & attach the bottom front of the graphic to the adhesive on the white plastic leader. Be sure to align the edge of the graphic to the first red line nearest the adhesive.

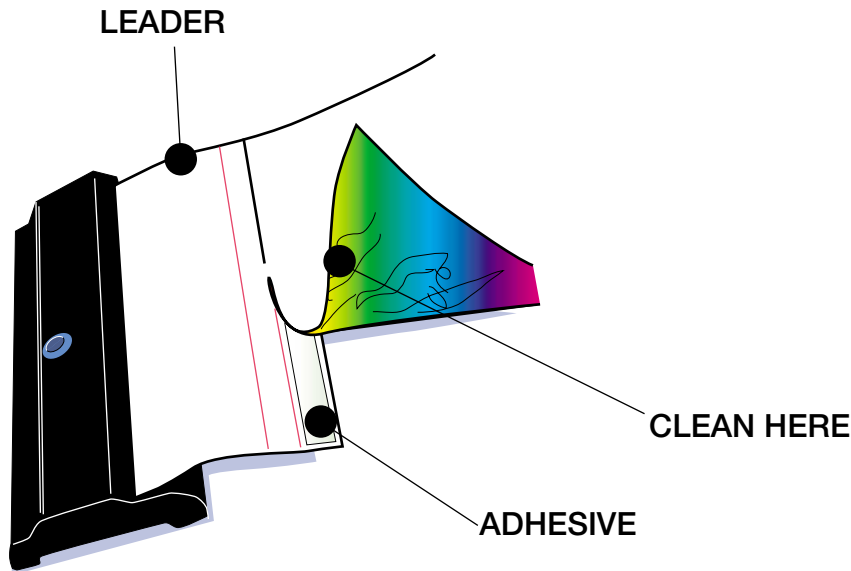

5

After the graphic has been applied to the base unit, the adhesive tape must cure for a minimum of 24 HOURS without spring tension. Failing to follow this procedure will cause the adhesive to prematurely fail and damage the graphic.

6

After curing for 24 hours or more, activate the spring tension by removing the Allen key. Pull the key while holding on to the attached graphic panel. Slowly let the panel roll into the housing. Save the key under the system or in the bag.

**DO NOT REMOVE THE HEX KEY IN THE END OF THE UNIT UNTIL THE GRAPHIC PANEL IS APPLIED!**

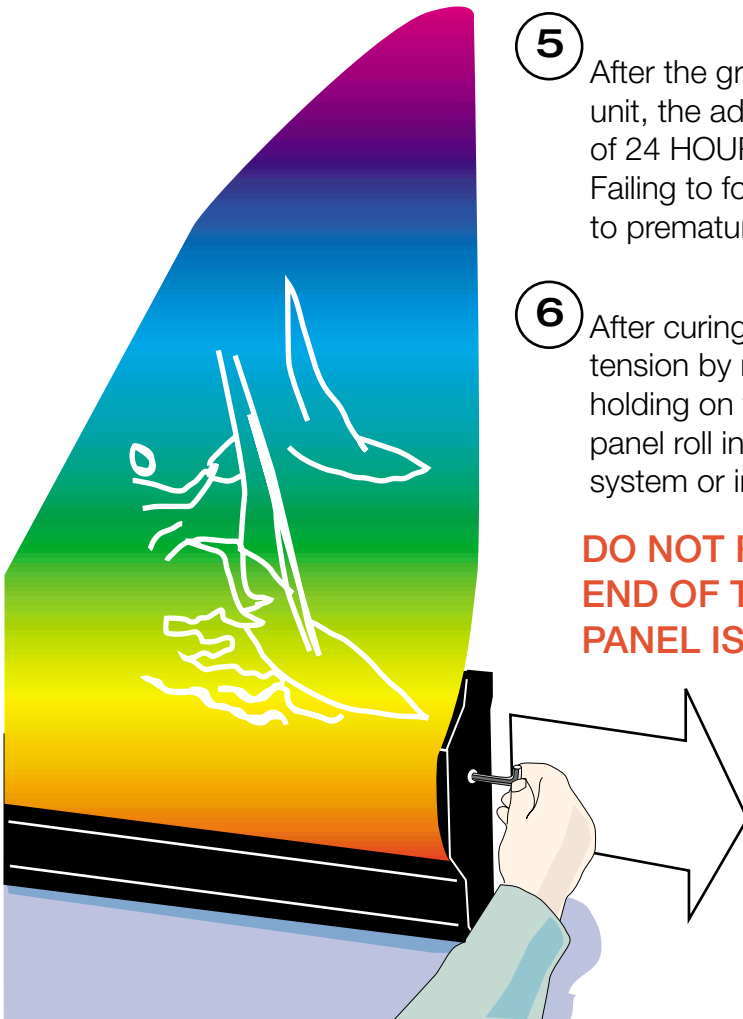

# HOW TO REPLACE AN EXISTING GRAPHIC PANEL

TO DO THE FOLLOWING PROCEDURE THESE ITEMS WILL BE NEEDED.

DENATURED ALCOHOL



CLOTH TOWEL



UTILITY KNIFE

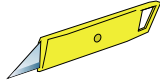

STRAIGHT EDGE

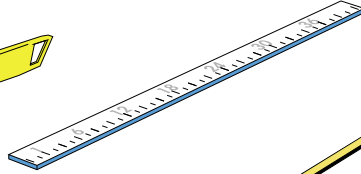

NEW MOUNTING STRIP

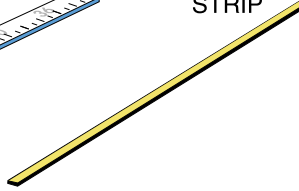

NIMLOK DOUBLE SIDED TAPE



PHILLIPS SCREWDRIVER

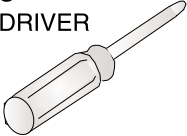

Pull out the panel completely.

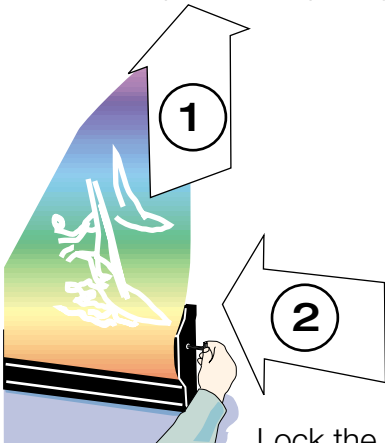

Lock the spring system with the key and remove the graphic.

4

Clean the graphic & leader with denatured alcohol before applying NIMLOK double sided tape\* on the white PVC.

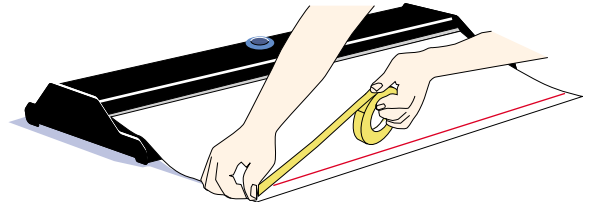

3

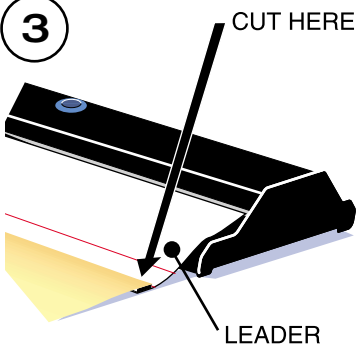

Using a straight edge, cut off the panel at the red line near the adhesive.

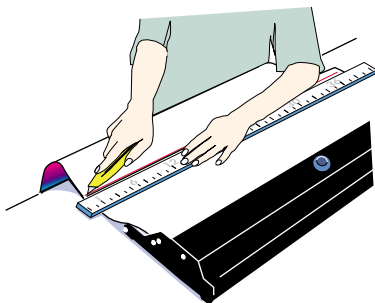

5

Unscrew the 6 mounting screws and pull out the old graphic from the handle.

**DO NOT REMOVE THE BLACK PLASTIC CAPS!**

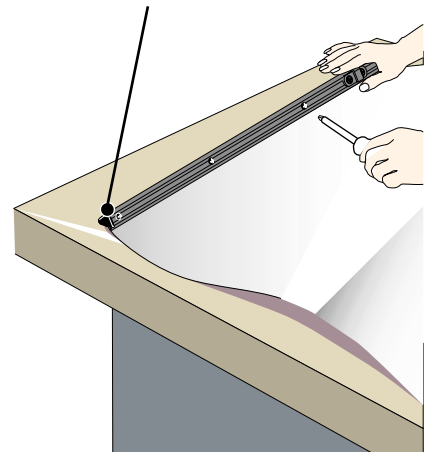

\*NIMLOK RECOMMENDS ONLY USING ADHESIVE TAPES AVAILABLE THROUGH NIMLOK DISTRIBUTORS.

# HOW TO REPLACE AN EXISTING GRAPHIC PANEL

6

Apply denatured alcohol to a clean cloth and wipe the back side of the new graphic. On the mounting strip, peel off the covering on the adhesive and mount the strip to the top backside of the graphic.

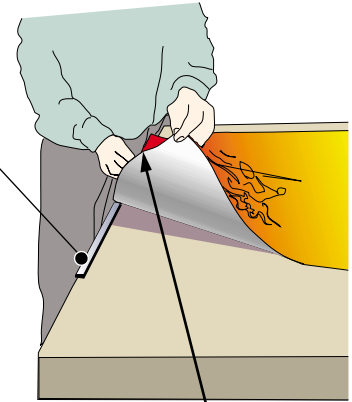

7

Slip the mounting strip & the graphic attached to it into the channel in the handle. (See DIAGRAM 1)

MOUNTING STRIP

CLEAN HERE

DIAGRAM 1

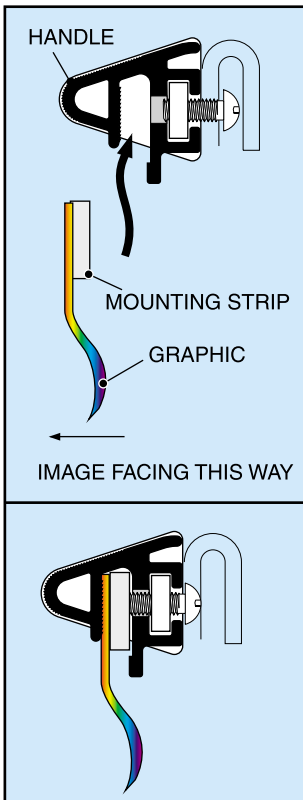

8

While holding the graphic panel into the handle slot, tighten the six mounting screws. Be sure not to over tighten the screws.

**DO NOT REMOVE THE BLACK PLASTIC CAPS!**

BACKSIDE OF GRAPHIC

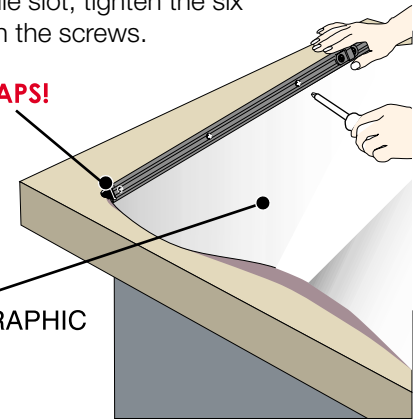

9

Wipe clean the bottom front of the graphic & attach the bottom front of the graphic to the adhesive on the white plastic leader. Be sure to align the edge of the graphic to the first red line nearest the adhesive.

10

After the graphic has been applied to the handle and the base unit, the adhesive tape must cure for a minimum of 24 HOURS without spring tension. Failing to follow this procedure will cause the adhesive to prematurely fail and damage the graphic.

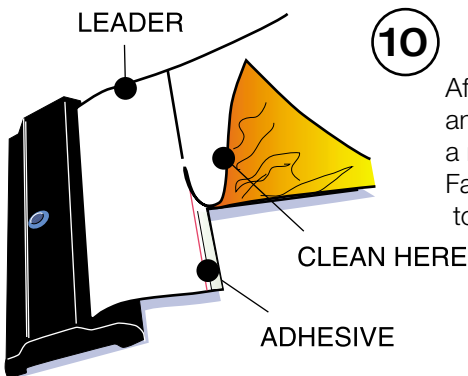

11

After curing for 24 hours or more, activate the spring tension by removing the Allen key. Pull the key while holding on to the attached graphic panel. Slowly let the panel roll into the housing. Save the key under the system or in the bag.

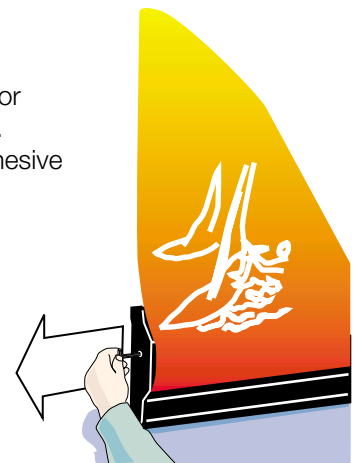

**DO NOT REMOVE THE HEX KEY IN THE END OF THE UNIT UNTIL THE GRAPHIC PANEL IS APPLIED!**

\*Contact your Nimlok distributor for the proper materials.

# HOW TO REAPPLY A GRAPHIC PANEL TO THE ROLLER

TO DO THE FOLLOWING PROCEDURE THESE ITEMS WILL BE NEEDED.

DENATURATED ALCOHOL

CLOTH TOWEL

NIMLOK DOUBLE SIDED TAPE

PHILLIPS SCREWDRIVER

MASKING TAPE

1

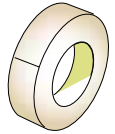
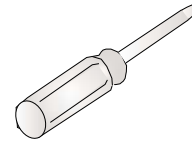

Remove the two upper screws on both ends.

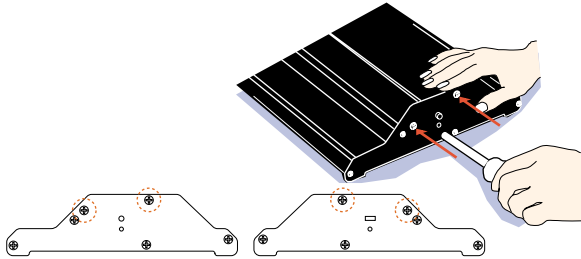

2

Unfold the cover.



3

Wind up the white PVC & tape it to the roll with masking tape.

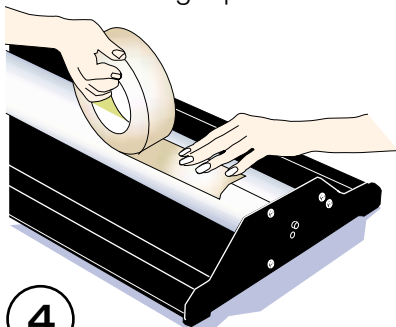

4

Activate the spring by rolling the roller away from yourself until it stops. (approx. 45 turns) Then let it go back one revolution.



5

Lock the spring system with the key. Remove the tape and roll out the PVC. Put the cover back in its place and reinstall the screws.

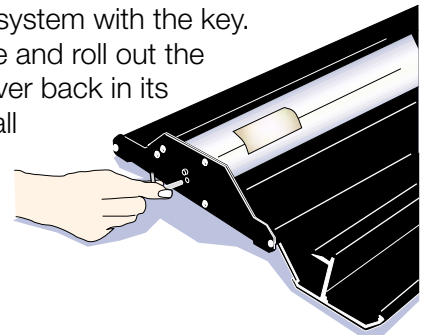

6

Make a Cut 1/2" from the end of the white leader to remove the old adhesive tape.

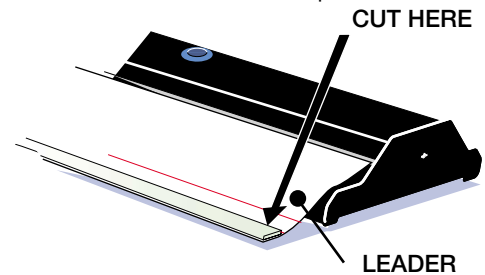

7

Place a new special double-adhesive tape\* strip between the end of the white PVC sheet and red line.

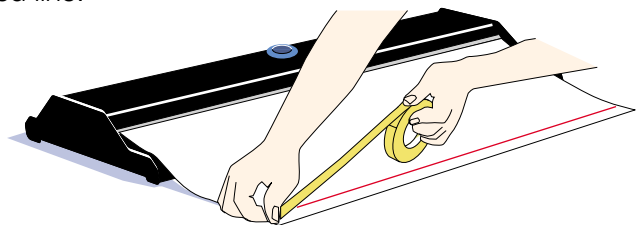

8

Mount the panel according to the instructions on pages 1 & 2. Be sure to let the tape cure for 24 hours before releasing the spring tension.

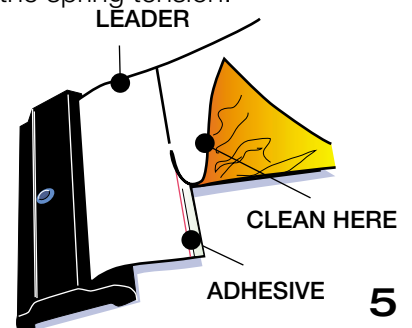

\*NIMLOK RECOMMENDS ONLY USING ADHESIVE TAPES AVAILABLE THROUGH NIMLOK DISTRIBUTORS.

# WHAT TO DO WHEN YOU ACCIDENTALLY PULL THE PIN

TO DO THE FOLLOWING PROCEDURES THESE ITEMS WILL BE NEEDED.

PHILLIPS SCREWDRIVER

MASKING TAPE

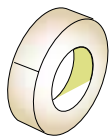
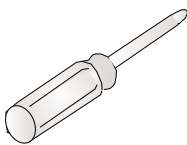

1

Remove the two upper screws on both ends.

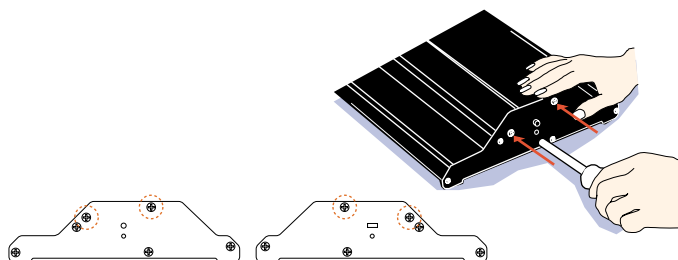

2

Unfold the cover.

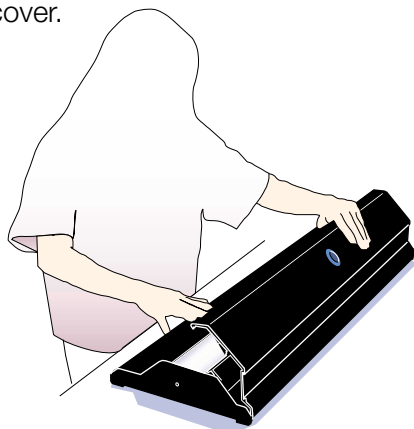

3

Wind up the white PVC & tape it to the roll with masking tape.

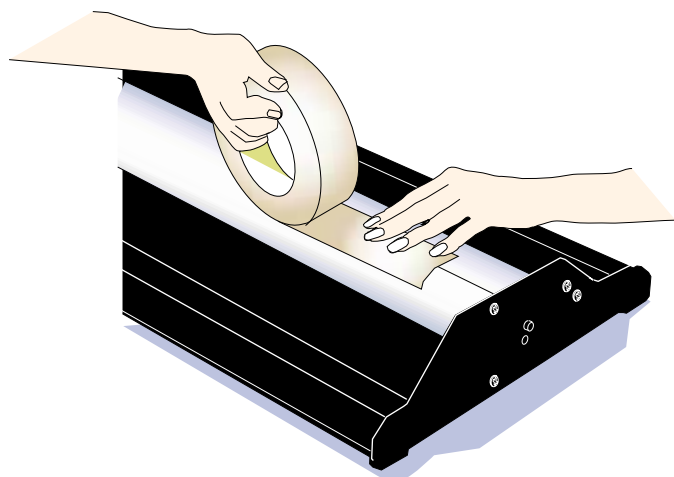

4

Activate the spring by rolling the roller away from yourself until it stops. (approx. 46 turns) Then let it go back one revolution.



5

Lock the spring system with the key. Remove the tape and roll out the PVC. Put the cover back in its place and reinstall the screws.

