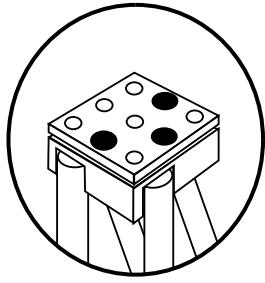
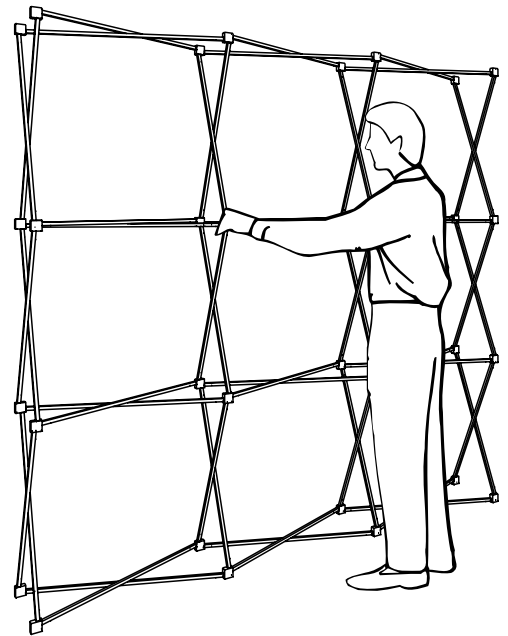
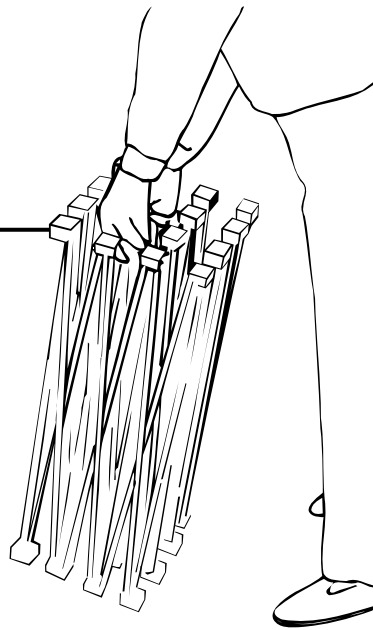
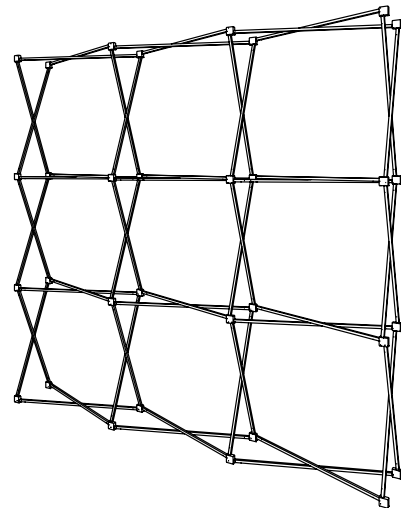
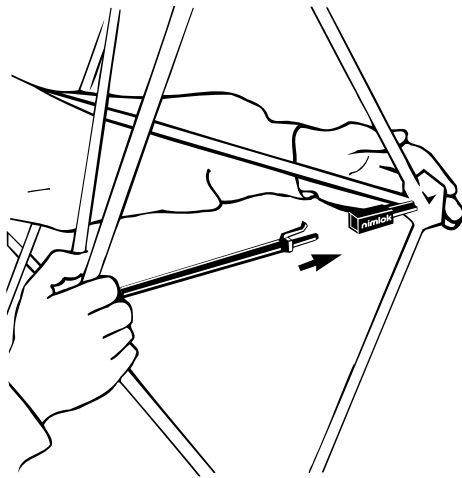

**QUICK REFERENCE PACKING GUIDE FOR
10' CURVED UNIT WITH LIGHTS & COUNTER**

1**OPENING THE FRAME**

3 red Location Buttons should be positioned at the top of the frame.

**2****3****ATTACHING CHANNEL BARS****Hinged Channel Bars**

- 1) Hook Channel Bar into bottom hub.
- 2) Hook Channel Bar into top hub.
- 3) Snap Channel Bar into place on two center hubs.

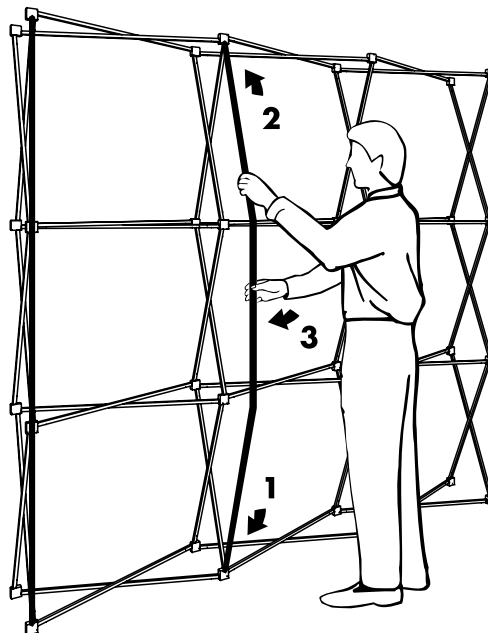
**Individual Channel Bars**

Individual Channel Bars snap into place as shown.

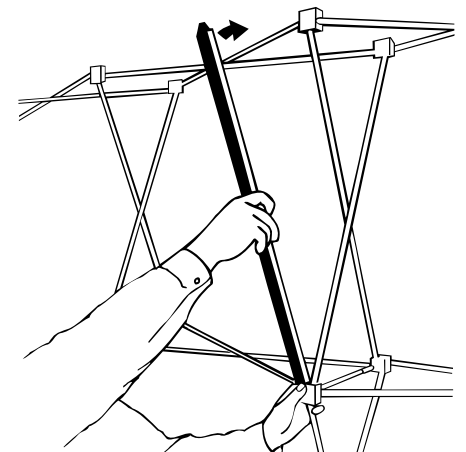

4

ATTACHING PANELS

To attach panels, start with Panel #1 on the left side of the unit, as you face the front of the unit.

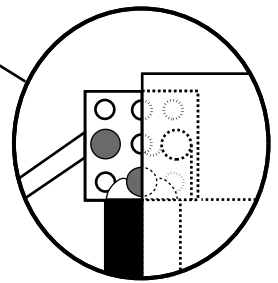
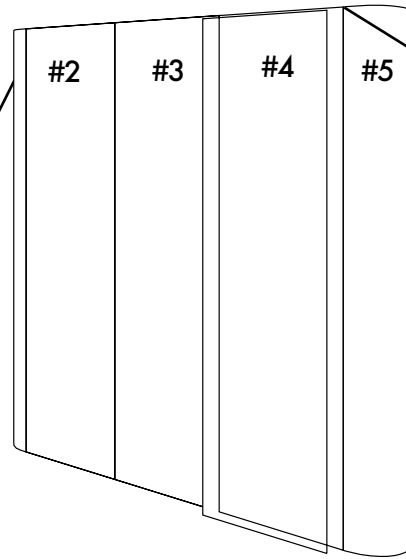
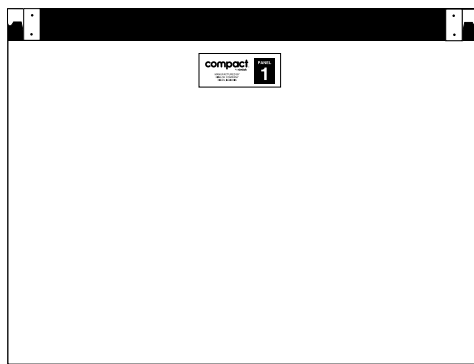

Panels hook onto red location buttons.

5

Attaching Lights

Unit may be tipped forward for easy Light installation.

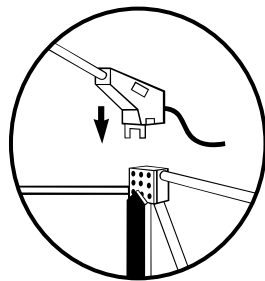

Horizontal Channel Bars

On Straight units only, the horizontal Channel Bars attach to the top holes of the bottom hubs.

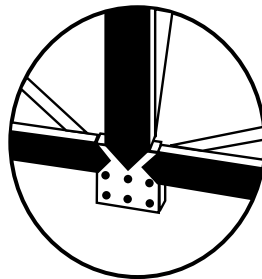

Stabilizer Feet

Stabilizer Feet are needed only on Straight units.

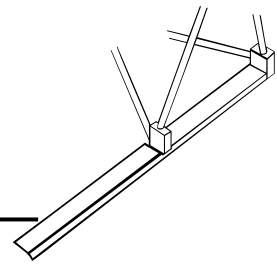
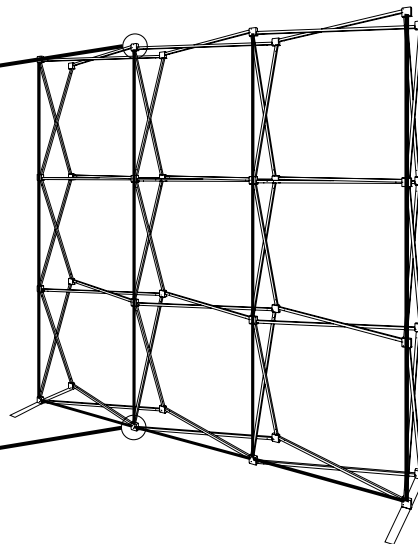

6

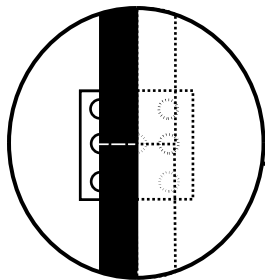

Make sure panel edges align with the center line on the magnetic Channel Bar.

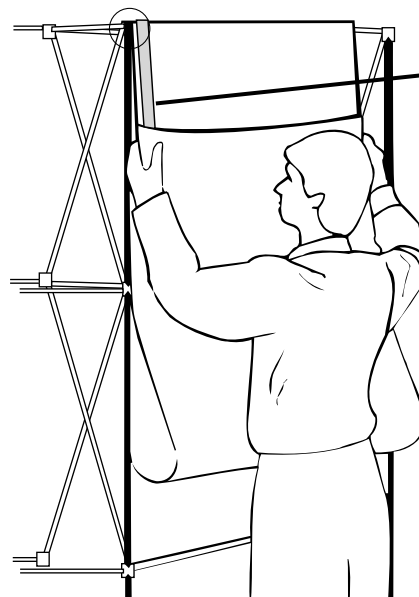
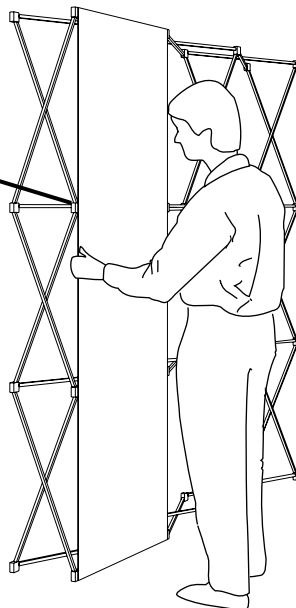

Straight Systems

Use the Panel Assembly Bar to keep panels rigid while assembling and dismantling Straight Systems.

CCK2 CASE-TO-COUNTER CONVERSION

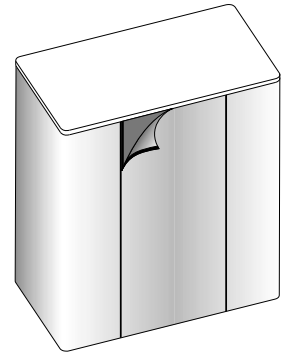
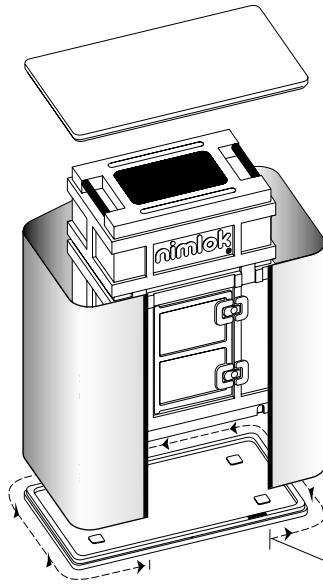
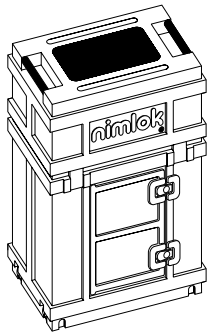

Start Case-To-Counter Outer Panel here.

ASSEMBLING LIGHTED HEADERS

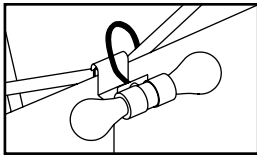
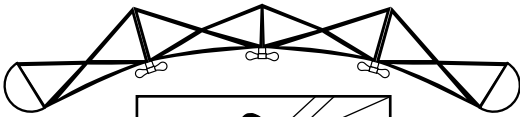

- 1) Attach Double-Bulb Fixture to the inside Frame hubs.
- 2) Assemble Header Frame, then roll on Lexan graphic overlay.
- 3) Hang Header on 'H' hooks located on the outside Frame hubs.

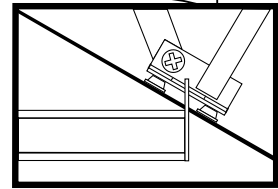
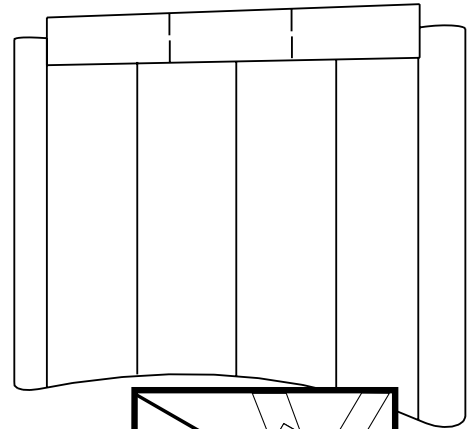
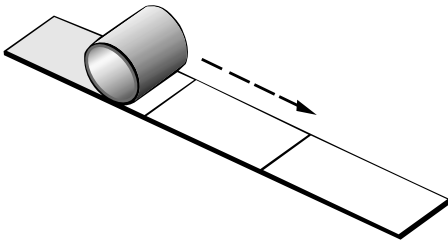

LIGHT BOX ASSEMBLY

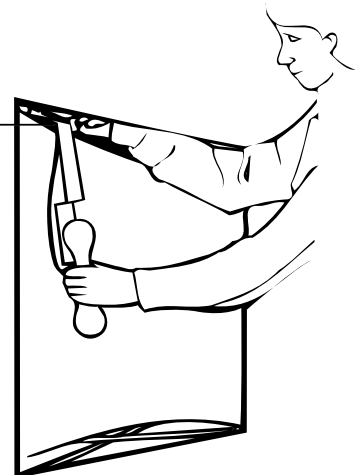
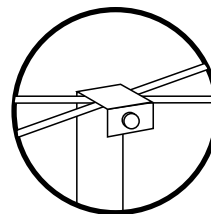
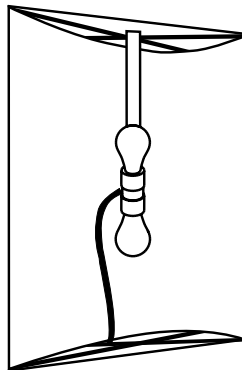

- 1) Attach Light Box backer.
- 2) Secure Light Fixture by tightening the thumb screw on the hanging Fixture.

BUBBLE PANELS

Attach the Double-Bulb Fixtures to the frame where the bubble panel will be placed.

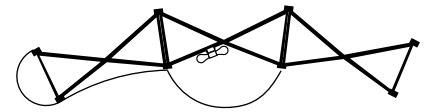
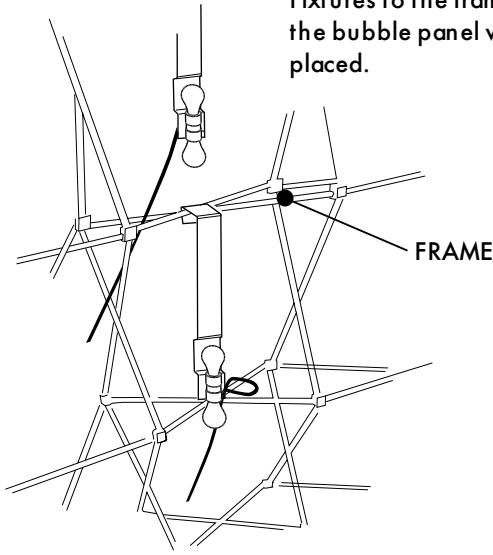

Apply the Bubble Panel's magnets to the Channel Bars and allow the panel to bow forward.

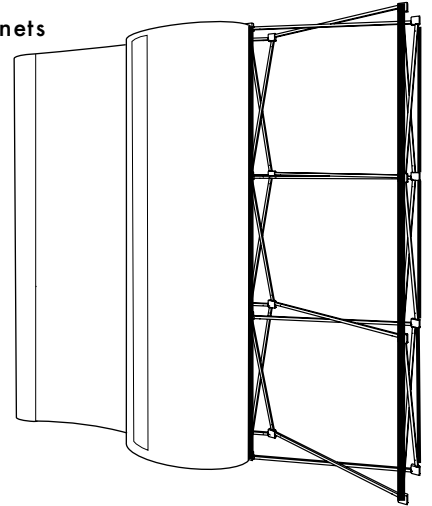

SHADOWBOX ASSEMBLY

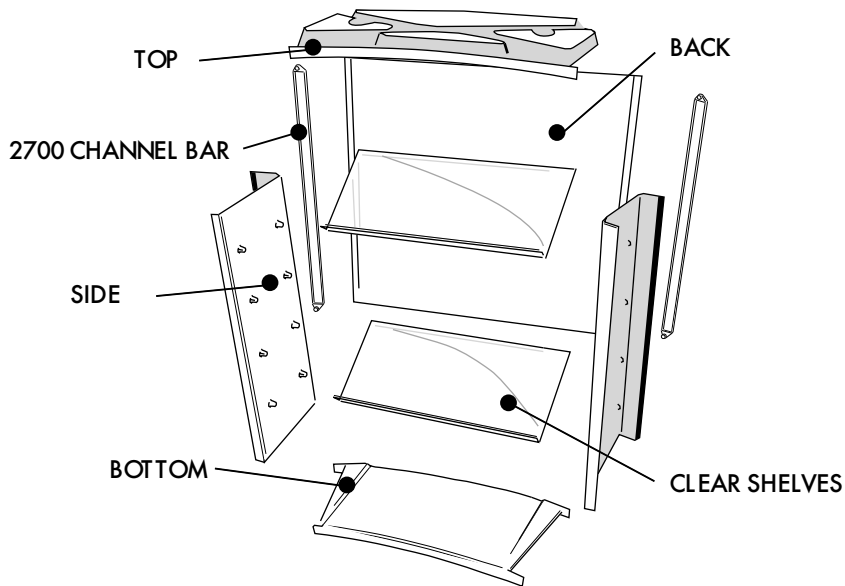

1 After installing the Channel Bars, insert the Top & Bottom into the Frame.

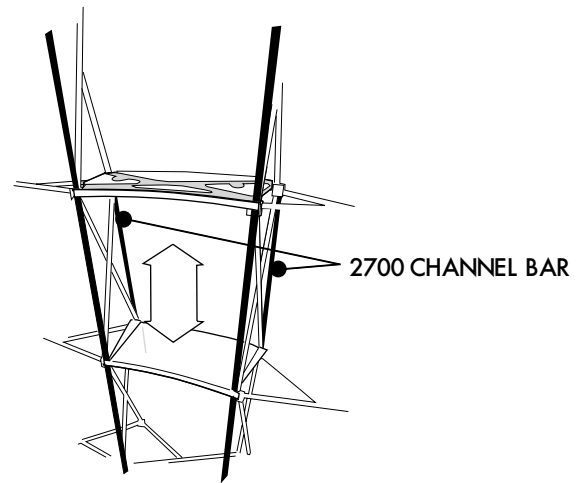

2 While holding up the Top, insert the Sides between the Top & Bottom.

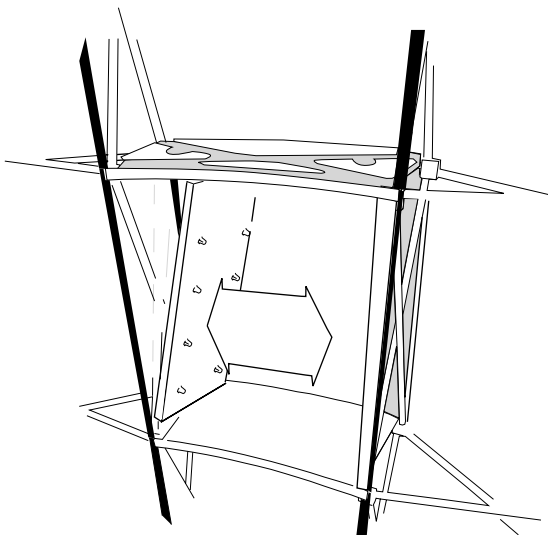

3 To finish the installation, slide in the Clear Shelves & attach the Back.

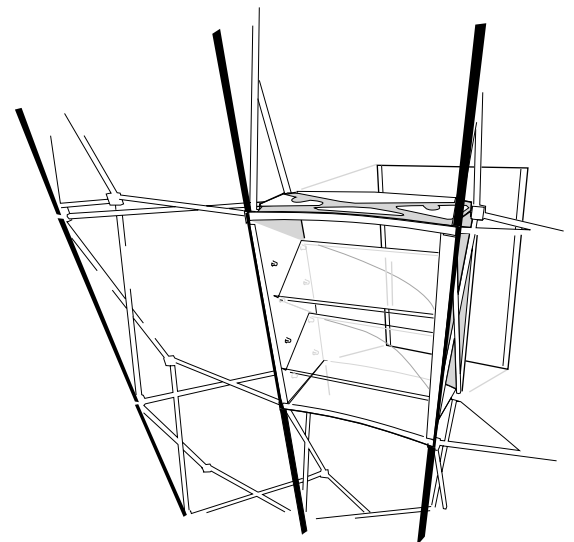

ALWAYS ROLL UP PANELS WITH FABRIC FACING FABRIC AND MAGNET FACING MAGNET.

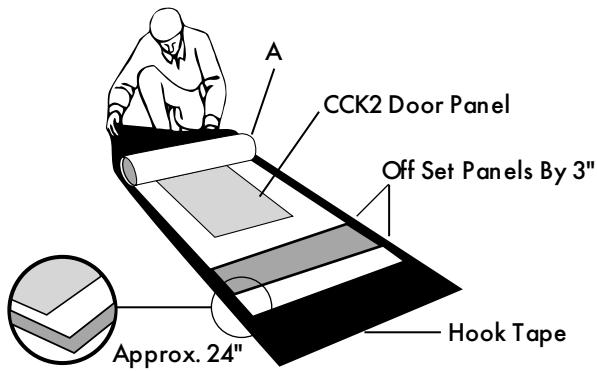

1) Lay Panel Wrap logo down, with the Hook Tape side facing up. Position the first panel approximately 24" below the Hook Tape. All Panel hooks must be placed at the end marked "A".

ROLL UP PANELS AND SECURE THE WRAP USING THE HOOK AND LOOP TAPE FASTENER.

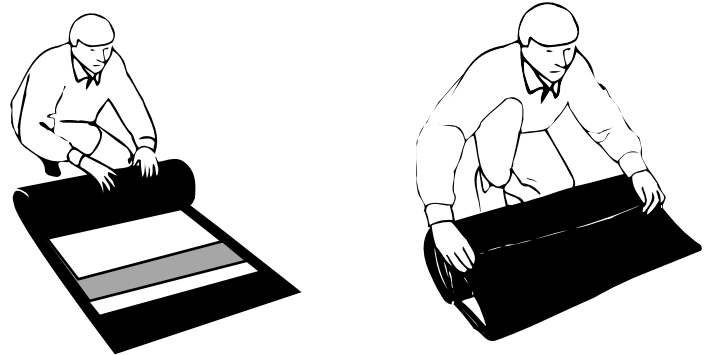

2) Stack Panels largest to smallest & offset the panels by approximately 3". Include the CCK2 door panel.
3) Roll up panels together within Wrap and secure with Hook & Loop Tape.

COMPACT AND CASE TO COUNTER CONTENTS

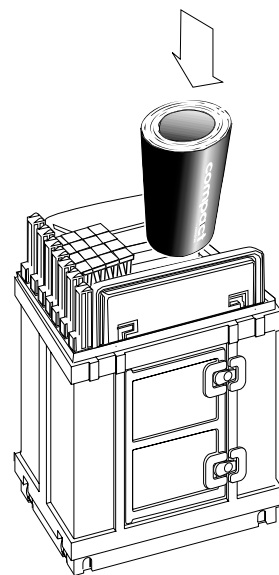
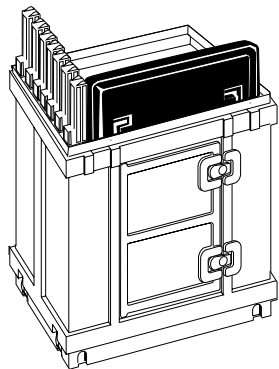
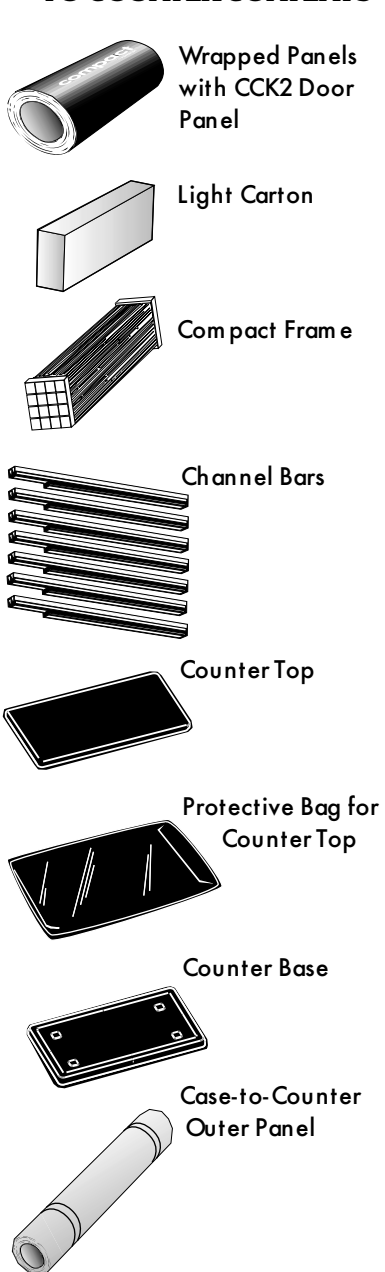

PACKING INSTRUCTIONS

1. Insert Channel Bars upright into the holder in the bottom of the case. Slide the Counter Base into the case along the door side.

2. Place the Counter Top in the Protective Bag, then place it in the case along the side opposite the door.

3. Pack the Frame next to the Channel Bar holder.

4. Place the wrapped Panels between the Counter Base and Counter Top.

5. Roll up the Case-to-Counter Outer Panel. Secure it with rubber bands & insert it in the center of the Wrapped Panels, into the well in the bottom of the case.

Slide the Light Carton between the Frame and Counter Base.

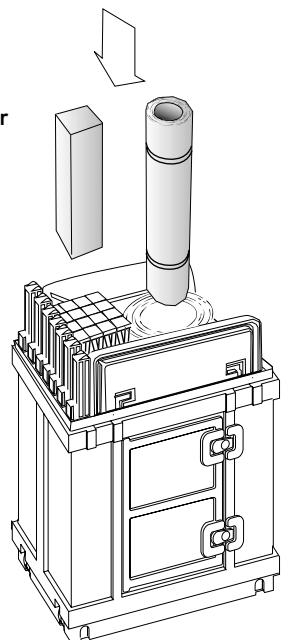
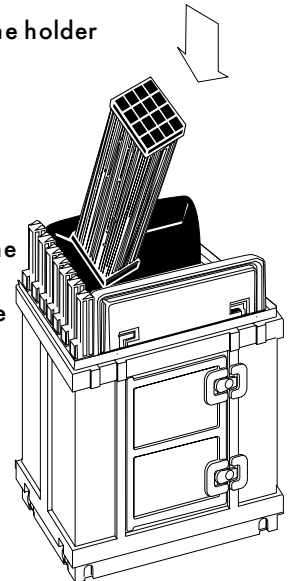

Refer to front Cover for packing diagram.